

HYBALANS+

Prolunga isolata EPP L=500

Extension insulated EPP L=500



Cod.	40 048 04 80	40 048 04 70	40 048 04 90	40 048 04 60
Di	125	150	160	180
De	155	180	190	210
L	185	210	220	240
H1	545	545	545	545
H	500	500	500	500
Box	1	1	1	1

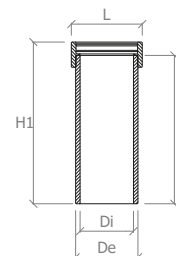

Prolunga isolata EPP L=1000

Extension insulated EPP L=1000



Cod.	40 048 04 82	40 048 04 72	40 048 04 92	40 048 04 62
Di	125	150	160	180
De	155	180	190	210
L	185	210	220	240
H1	1045	1045	1045	1045
H	1000	1000	1000	1000
Box	1	1	1	1

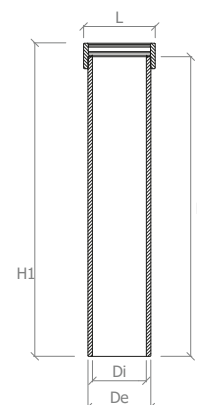

Curva isolata EPP 90°

Elbow insulated EPP 90°



Cod.	40 048 04 84	40 048 04 74	40 048 04 94	40 048 04 64
Di	125	150	160	180
De	155	180	190	210
L	185	210	220	240
A	250	250	250	260
B	203	203	203	214
Box	1	1	1	1

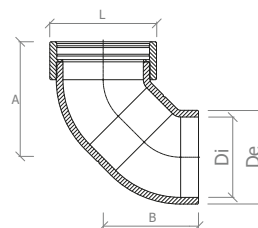

Curva isolata EPP 45°
Elbow insulated EPP 45°



Cod.	40 048 04 86	40 048 04 76	40 048 04 96	40 048 04 66
Di	125	150	160	180
De	155	180	190	210
L	185	210	220	240
A	188	188	188	193
B	58	59	59	62
Box	1	1	1	1

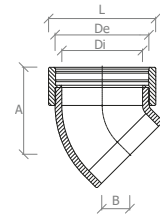

Manicotto isolato EPP
Sleeve joint insulated EPP



Cod.	40 048 04 88	40 048 04 78	40 048 04 98	40 048 04 68
Di	125	150	160	180
De	155	180	190	210
H	85	85	85	85
Box	1	1	1	1

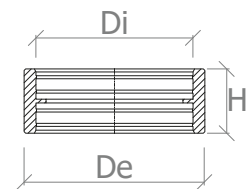

Fascetta di supporto 125-180
Ventilation ducting bracket 125-180



Cod.	40 047 04 59
A	191
B	50
C	139
D	63
E	750
Box	1

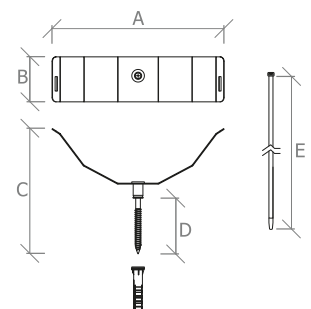

HYBALANS+

Terminale murale di ventilazione nero

Wall terminal ventilation black



Cod.	40 048 06 02	40 045 27 20	40 048 06 06	40 045 27 21
Dn	125	150	160	180
De	124	149	159	179
A	295	295	295	345
B	255	255	255	300
L	258	258	258	286
S	122	122	122	146
Box	1	1	1	1

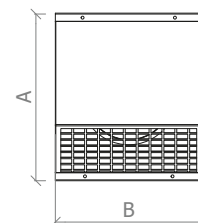
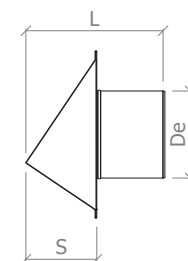

Terminale a tetto di ventilazione isolato L=1000 nero

Roof terminal ventilation isolated L=1000 black



Cod.	40 048 04 51	40 045 27 12	40 048 06 00	40 045 27 36
Di	125	150	160*	180
De	150	180	200	200
H	1000	1000	1000	1000
H1	535	635	635	635
Box	1	1	1	1

* Con adattatore 180-160
* With adapter 180-160

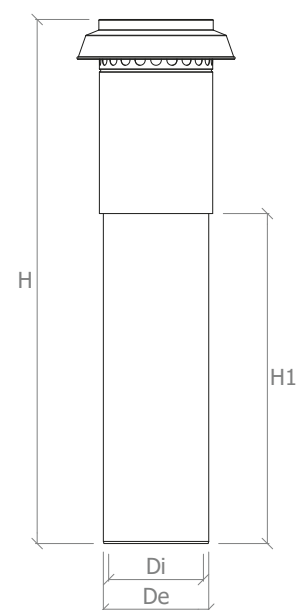

Faldale piano in alluminio

Flat roof flashing AL



Cod.	40 045 31 82	40 045 32 10
D	160*	204**
D1	430	420
H	150	115
Box	1	1

* Adatto per il diametro 125
* Suitable for diameter 125

** Adatto per i diametri 150 - 160 - 180
** Suitable for diameters 150 - 160 - 180

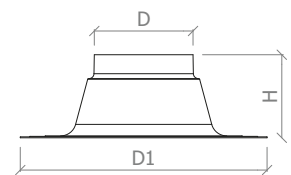

Tegola piombo

Roof tile PB

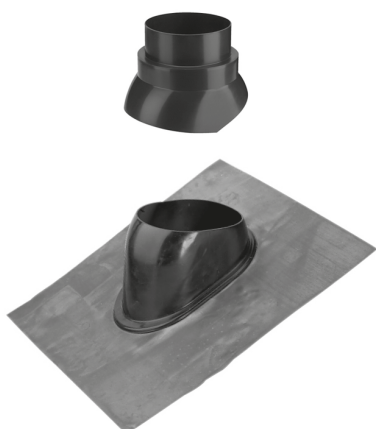

Cod.	40 045 35 46	40 045 40 40
A	500	1000
B	500	800
De	160*	205**
Box	1	1

* Adatto per il diametro 125
* Suitable for diameter 125

** Adatto per i diametri 150 - 160 - 180
** Suitable for diameters 150 - 160 - 180

